

# **The Practical Limitations of S Parameter Measurements and the Impact on Time-Domain Simulations of High Speed Interconnects**

Dennis Poulin  
Anritsu Company

## Outline

- **The challenge for SI Engineers**
- • **High Speed Serial Design Flow**
- • **S-parameter measurements – frequency considerations**
- • **Eye Diagrams and low frequency measurement data issues**
- • **Verifying simulation-measurement correspondence**
- • **Setting emphasis levels**
- • **Superposition vs. true mode stimulus for active device measurement**
- • **Resources**
- • **Questions**

## Background – challenge for SI Engineers

- Compliance with higher data rate standards
- Cost/performance trade-offs
- Locating Defects
- Measurement – simulation correlation
- Dealing with test fixtures
- Gaining confidence in models and 3D-EM Simulations
- Getting accurate eye diagram simulation

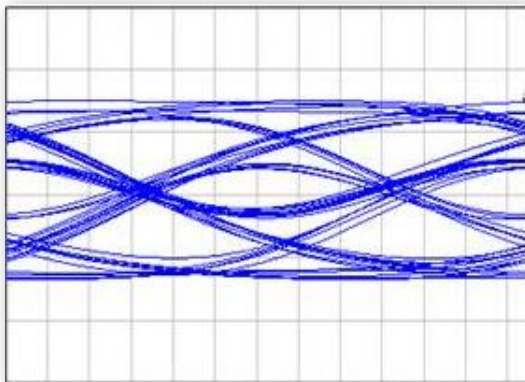

## Desired Result from VNA Measurements

- Enhanced causality & reduction of DC extrapolation errors
- Accurate models to accelerate design cycle
- Accurate eye diagrams

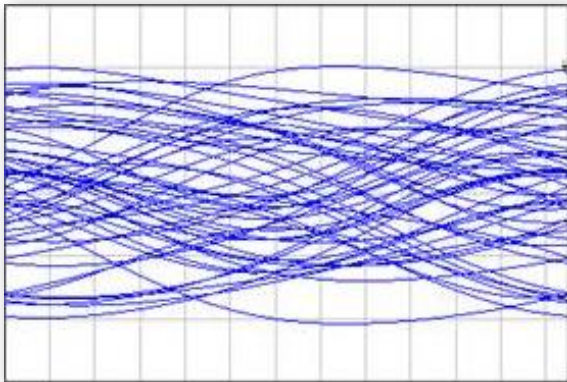

Poor S-parameter Data

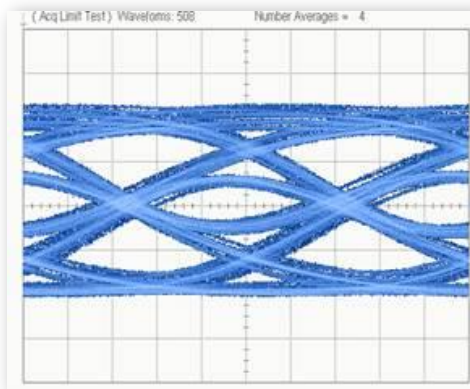

Actual performance

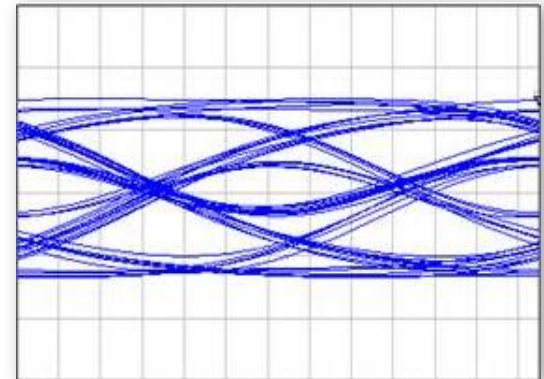

Good S-parameter Data

## Challenges for SI Engineers

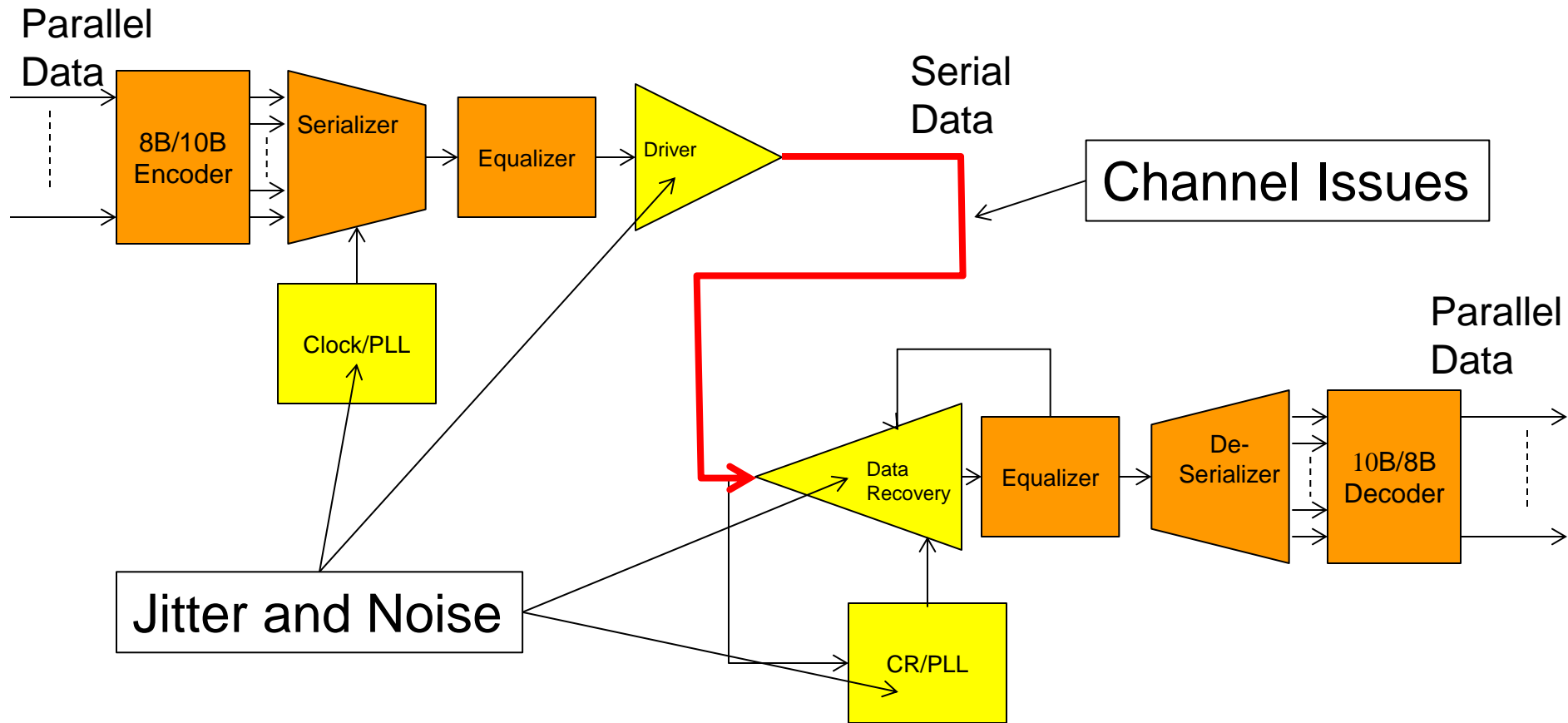

## Types of Channel

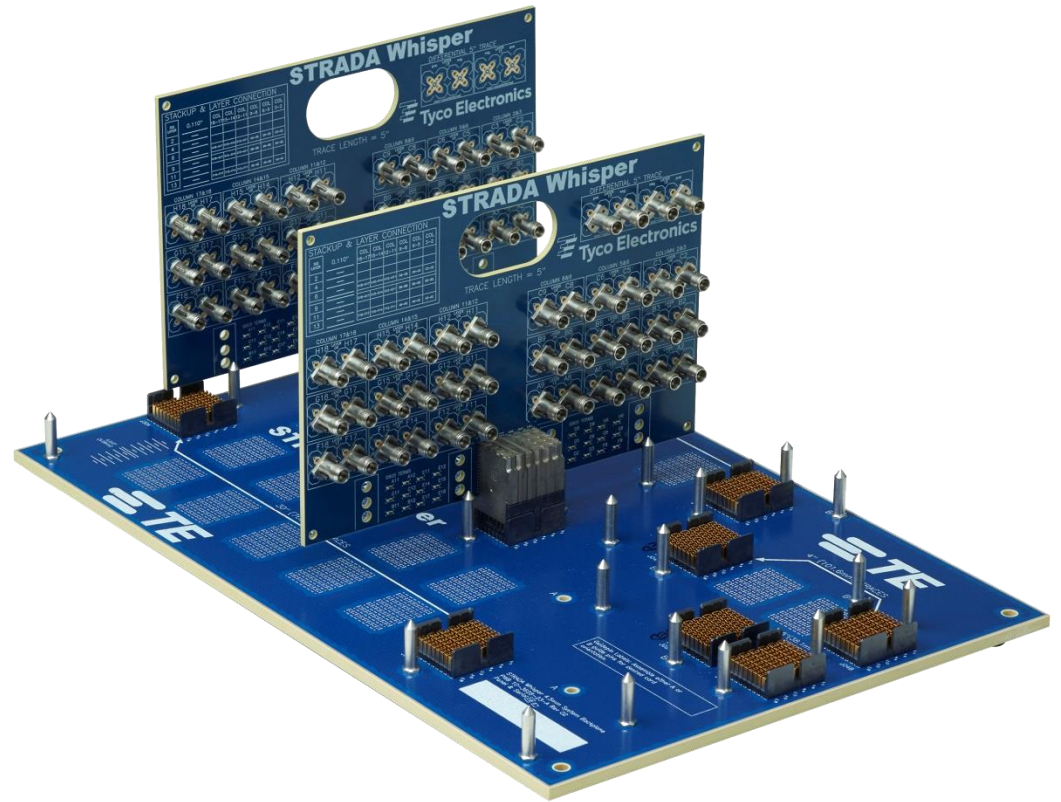

## Typical High Speed Design Flow

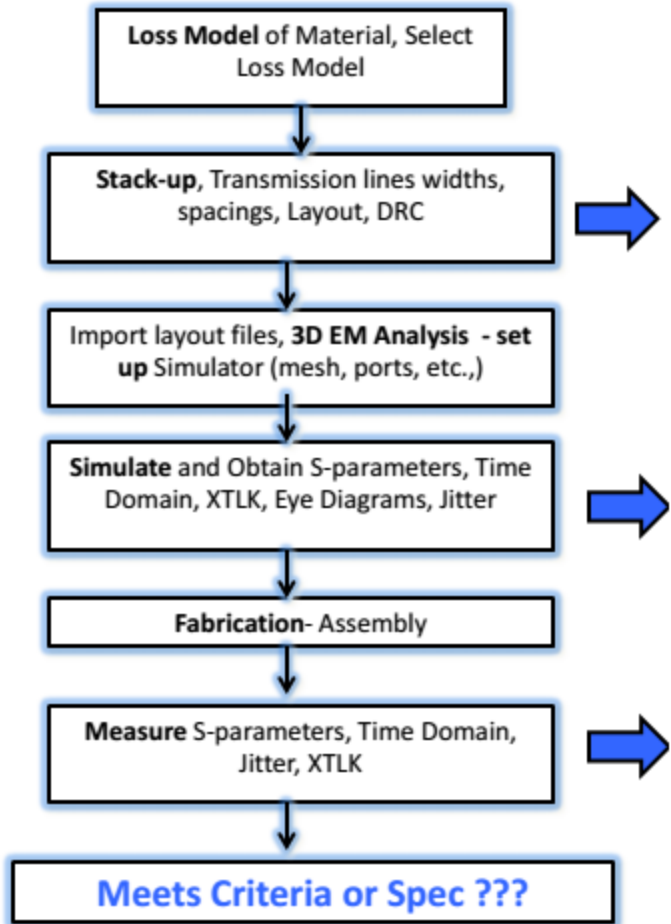

- No method to resolve issues with design miss
- Little benchmarking early in process
- Issues identified very late in process

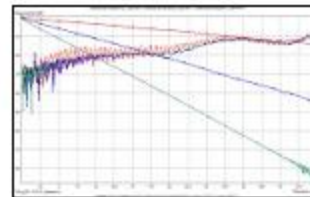
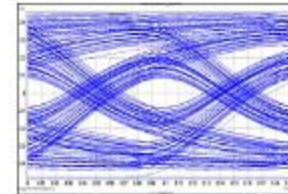
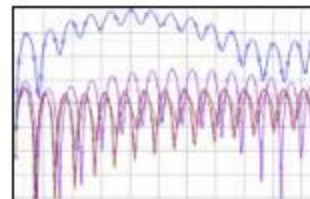
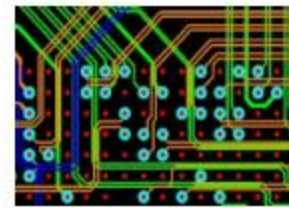
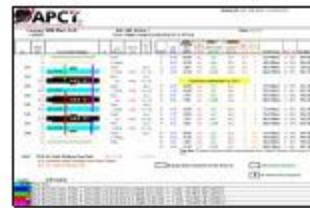

## If This Project Did Not Meet Objectives

The Design Flow has Critical Flow – No Easy Path to Resolve Problems!

### The Short List of Potential Problems

- 3D EM Simulation
  - Meshing
  - Port Boundaries
  - Material Properties and Loss Models
- Time domain simulations (eye diagrams and TDR) may have jitter issues
- Measurement Issues
  - Calibration Issues, VNA setup, Measurement Drift
  - Adapters

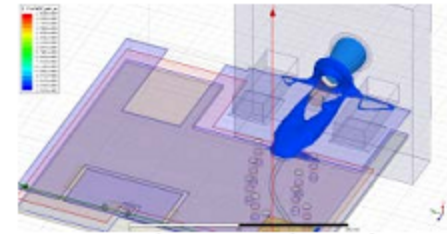

Port Boundaries and Meshing are two potential 3D EM issues resolved with benchmarking

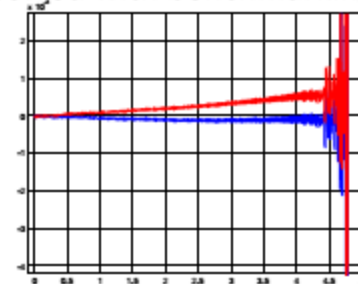

Time Domain Simulation Error due to Causality, poor DC extrapolation error



## Improved High Speed Design Flow

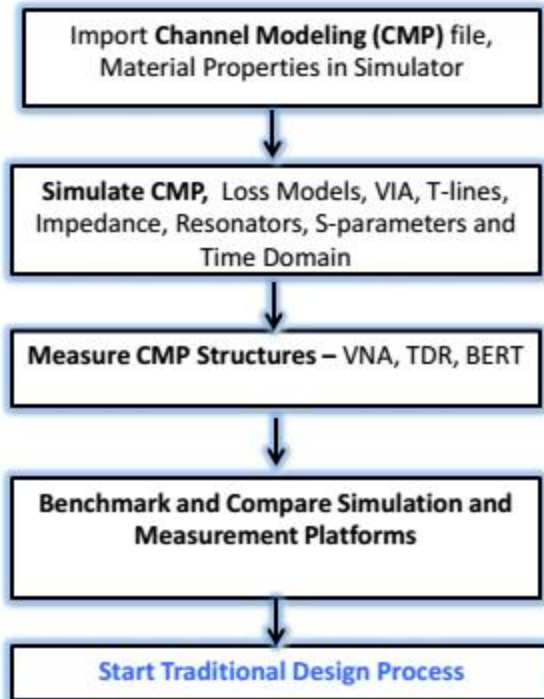

- Validate Loss Models *EARLY!*
- Compare S-parameters, Test for Quality (passivity, symmetry, causality, noise, deviation)
- Set up 3D EM simulator correctly – mesh, port boundaries, validate simulation check impedances, time and frequency domain

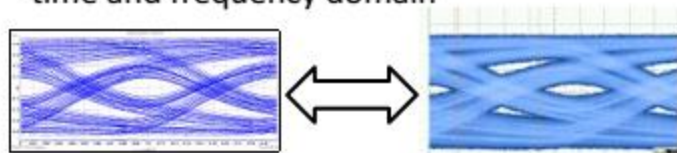

Compare simulated with measured Eye Diagrams

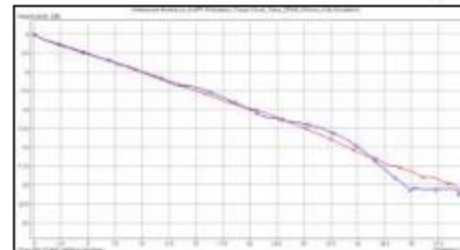

3D-EM simulation of 6inch CMP-28 Microstrip with VectorStar S-parameter Insertion Loss

## Transforms into the time domain

- Objective – find out how interconnects impact the eye diagram

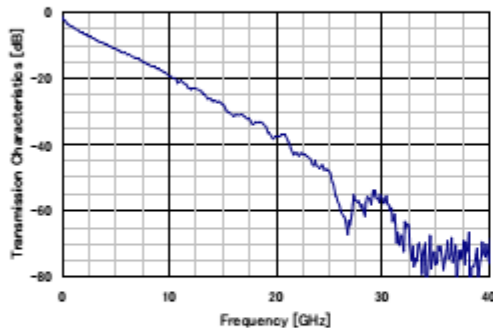

Is the true picture this?

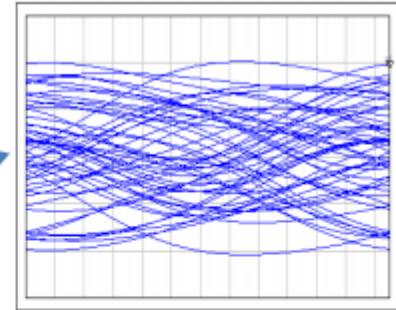

Or this?

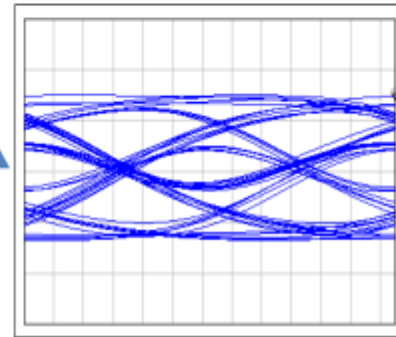

- S-parameters are either measured, simulated or both
- As bit rates increase S-parameters increase in frequency

## Channel Issues - Loss

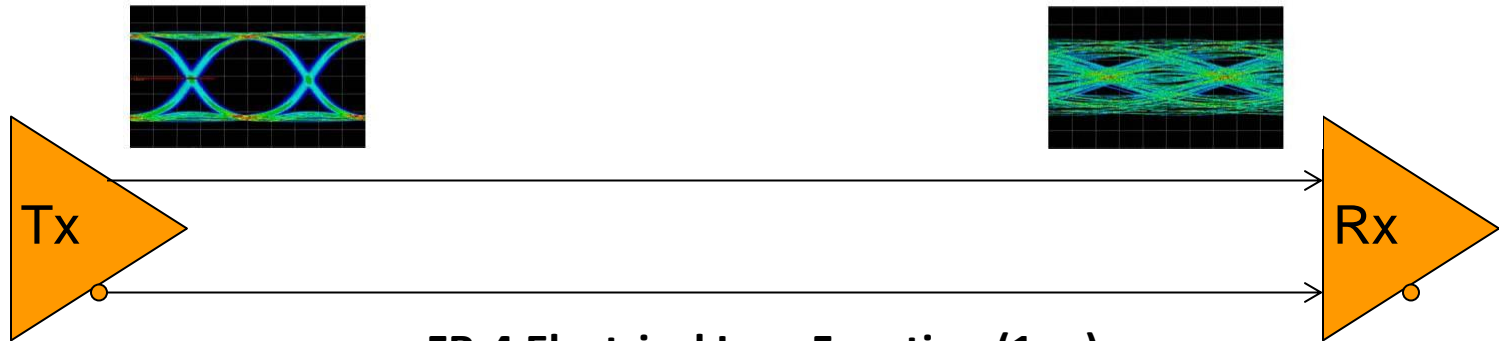

FR-4 Electrical Loss Function (1 m)

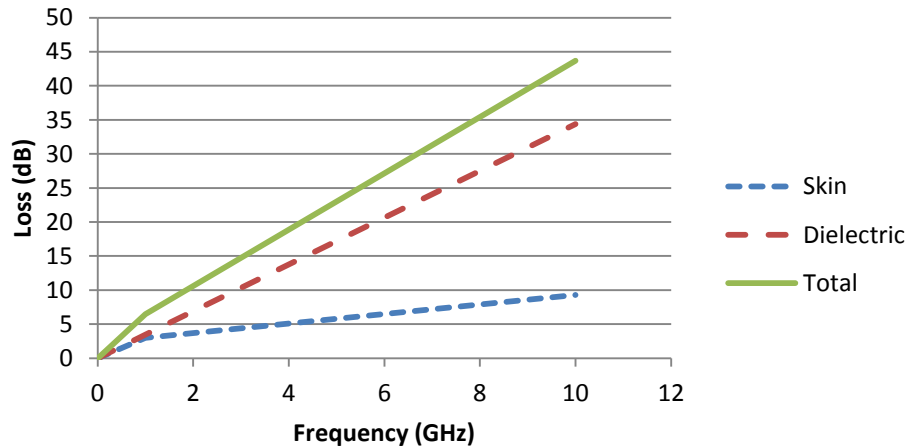

## Channel Issues - Loss

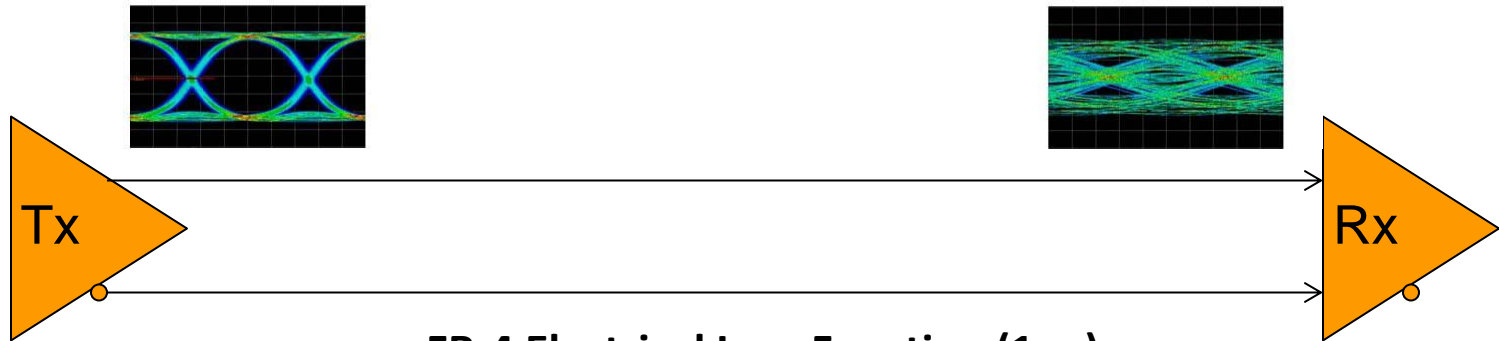

FR-4 Electrical Loss Function (1 m)

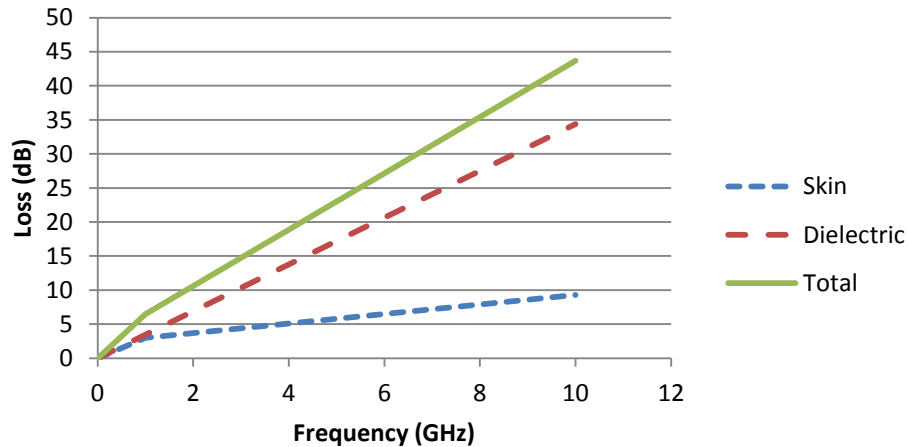

## Channel Issues - Loss

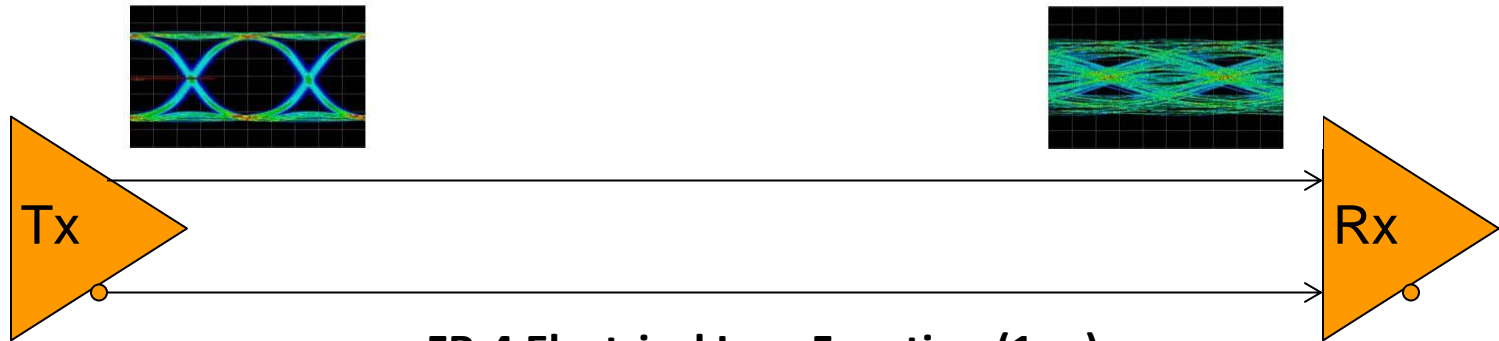

FR-4 Electrical Loss Function (1 m)

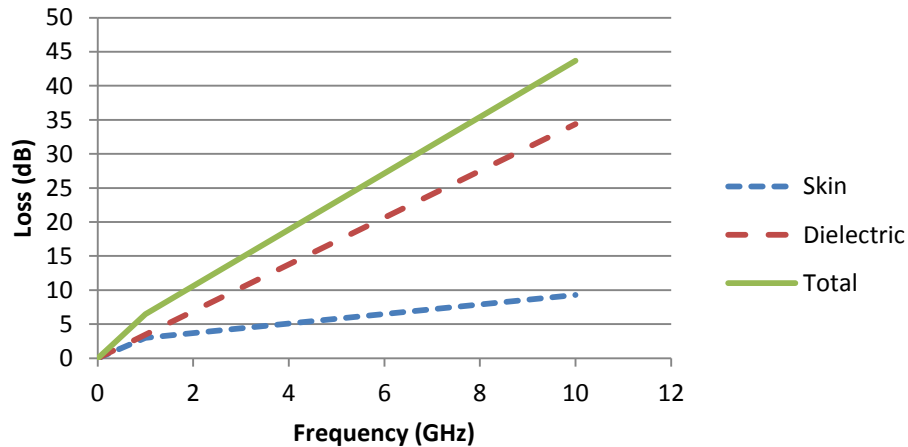

## Channel Effect

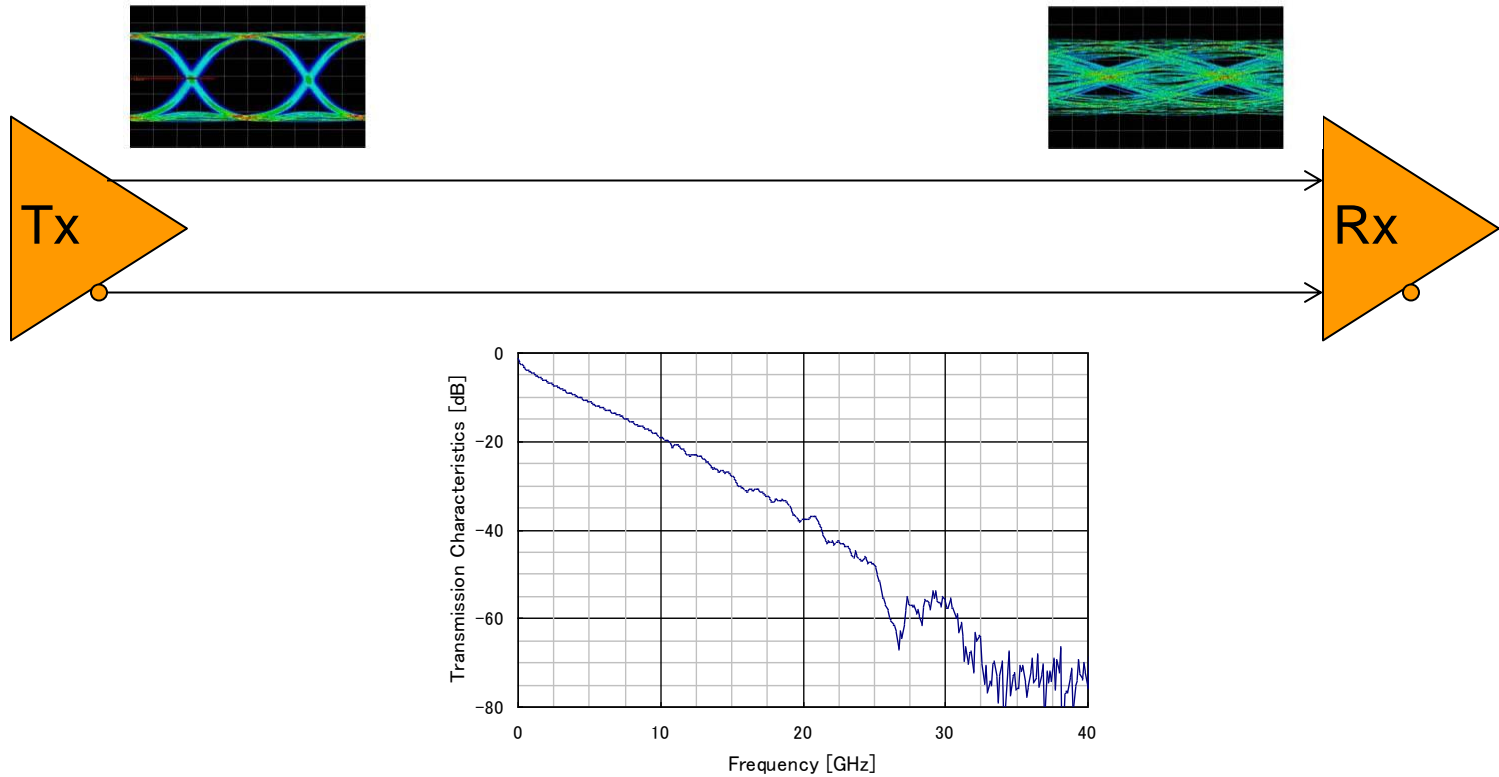

- Differential Transmission Characteristic of 27" backplane
- High frequency Attenuation closes eye

## Emphasis

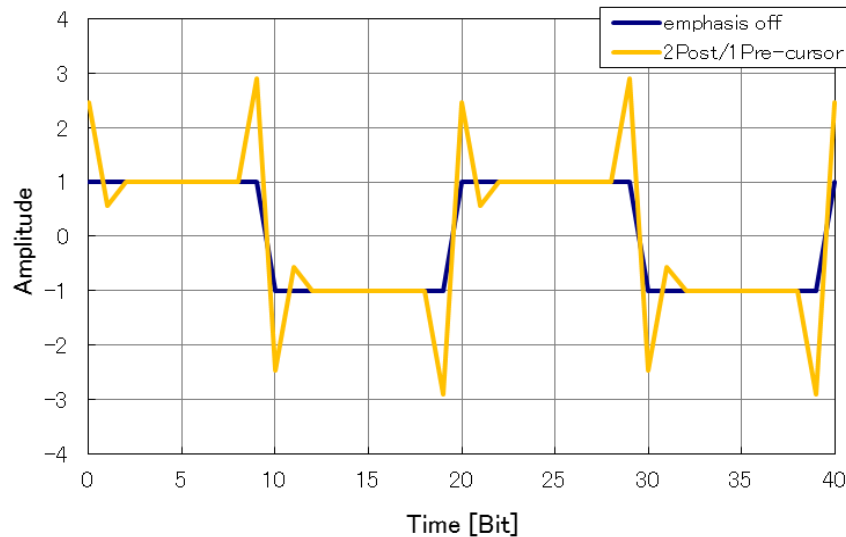

- Added to the Tx signal
- Sharpens the edges
- Adds more high frequency content to counteract high frequency attenuation of backplane
- Aim is to have open eye at Rx

## Using Emphasis

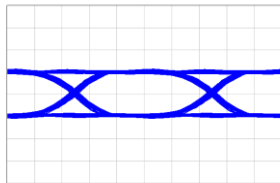

Input waveform with no emphasis

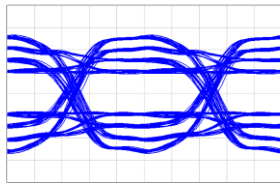

Input waveform with emphasis

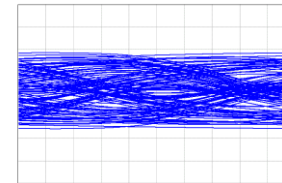

Simulated Using measured S-parameter data

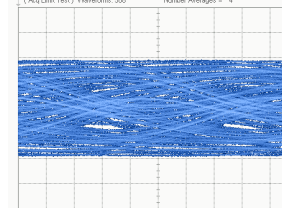

Measured using Oscilloscope

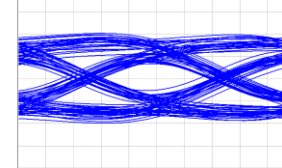

Simulated Using measured S-parameter data

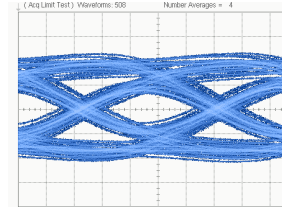

Measured using Oscilloscope

How to set the right degree of emphasis?



## Setting Ideal Emphasis

- **Challenge:** Difficult to find the ideal emphasis settings from the many possibilities
- **Problem:** Searching for ideal settings while verifying the output waveform
  - ◆ takes an extremely long time
  - ◆ hard to explain why those settings are ideal.
- **Solution:** Use VNA-captured S-parameter data to apply inverse DUT characteristics to input waveform

## Channel Issues - Structures

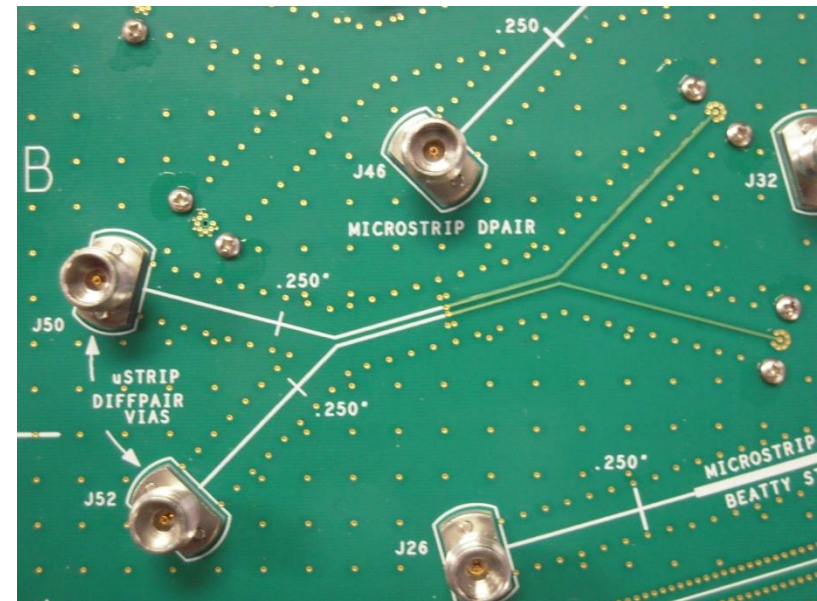
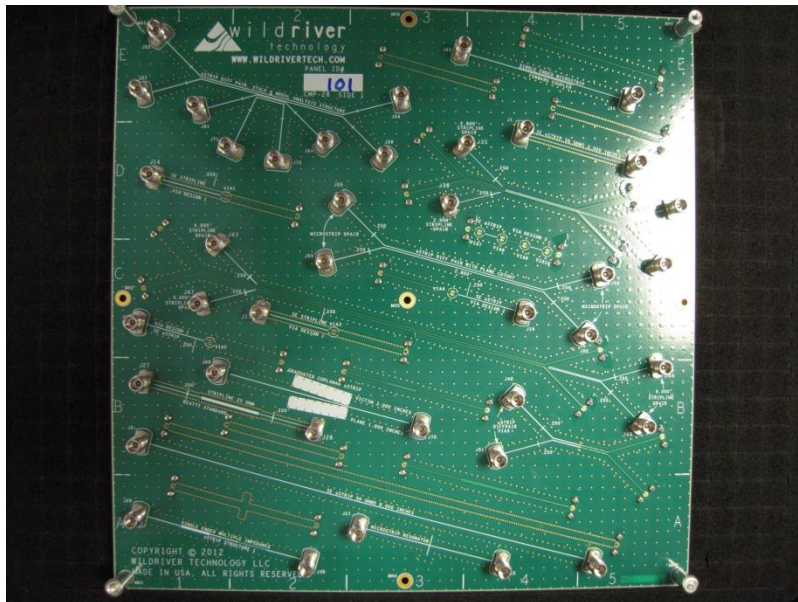

Channel artifacts (vias, impedance changes, ground plane issues etc.)

## Backplane Transmission Measurement

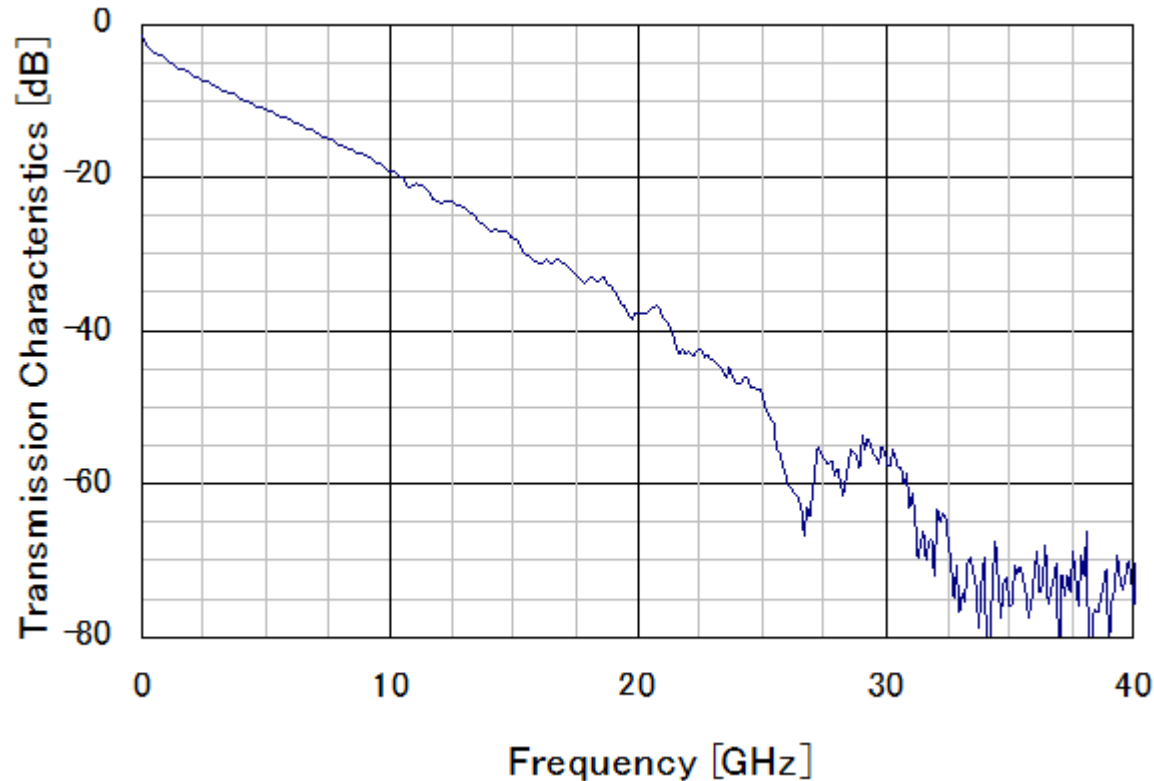

## Channel Issues – Crosstalk

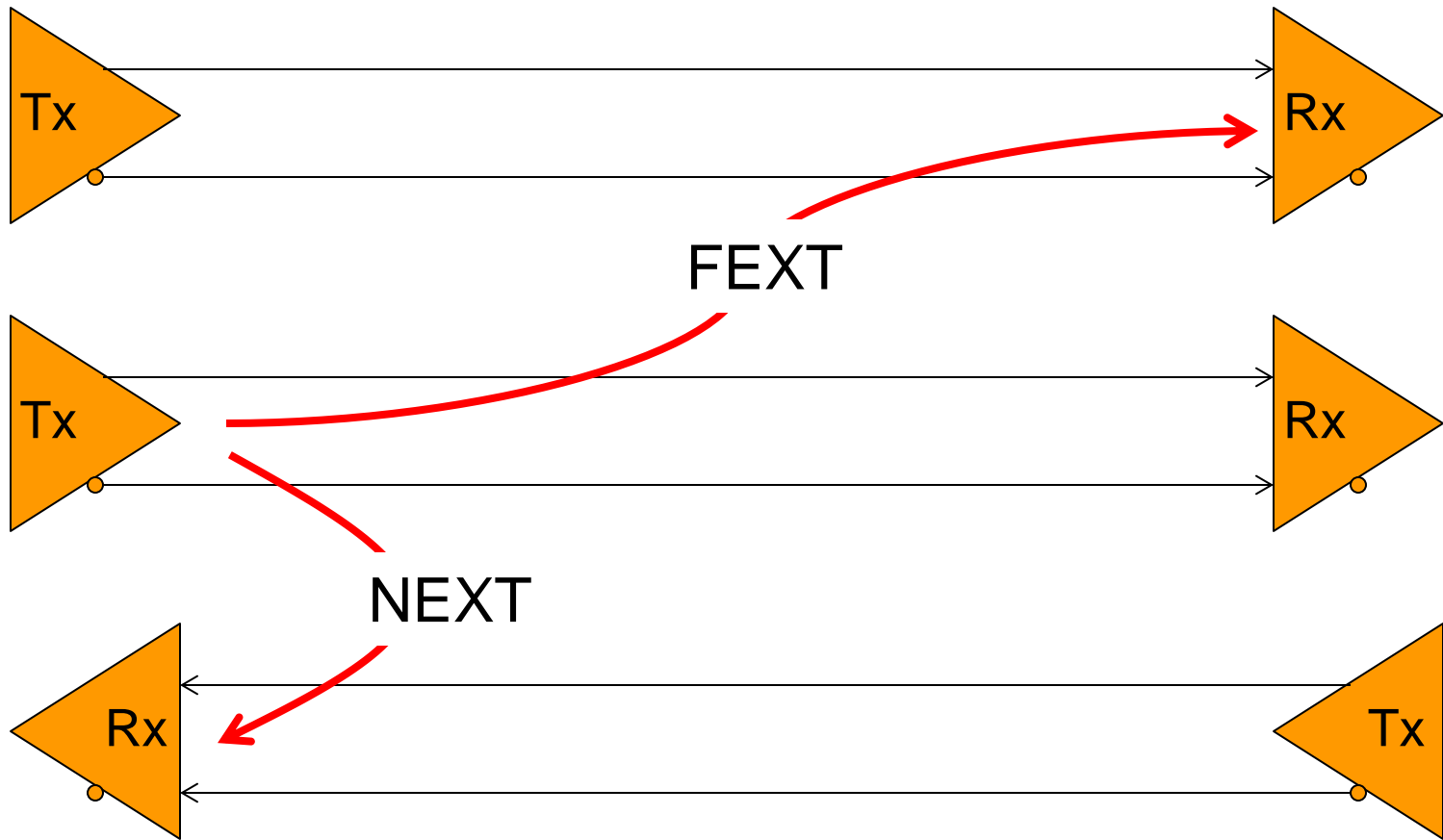

## VNA Measurements

- **Importance of Max and Min Frequency for Time Domain**
- **De-embedding**
- **Superposition vs. True Balanced**

## Importance of Maximum Frequency Range

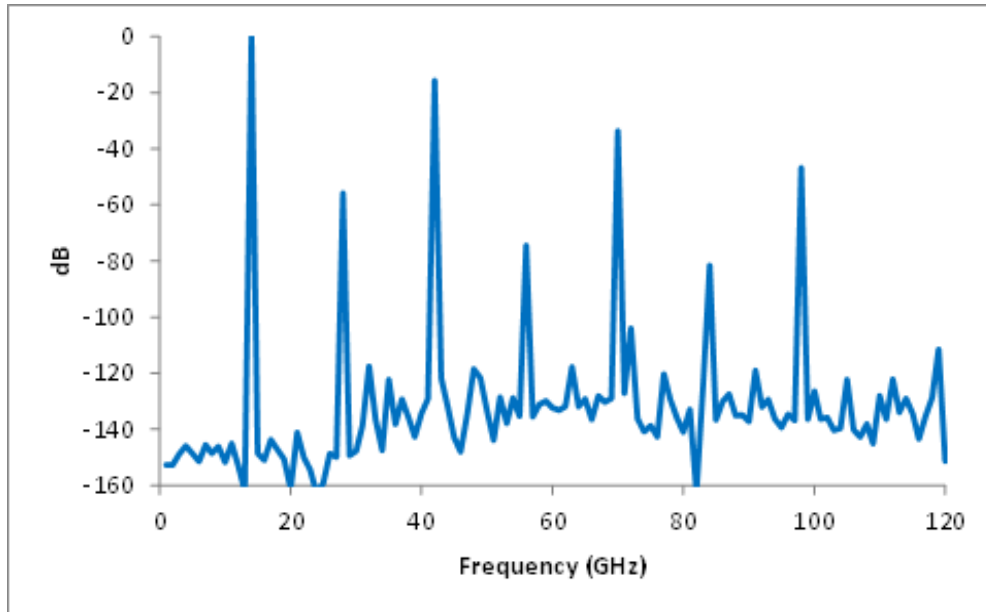

Harmonic Content of 28 Gbps NRZ clock signal

- Attenuating harmonics distorts signal

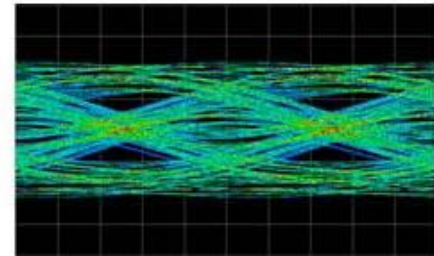

- Ideally measure to 5<sup>th</sup> harmonic

## Importance of Maximum Frequency Range

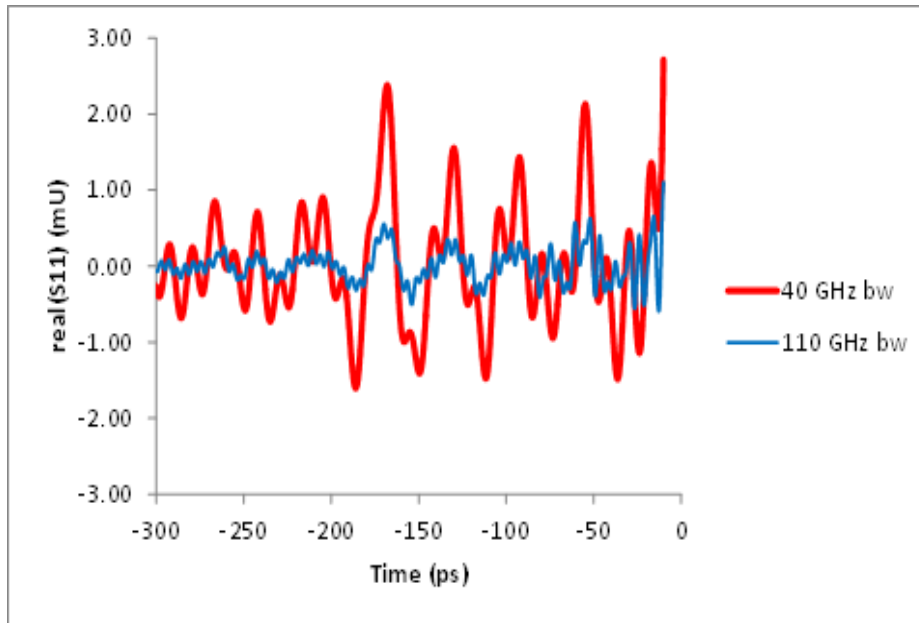

Non-Causal Results

- Lack of causality means output appears to occur prior to stimulus
- Can cause unstable simulations
- Higher frequency data improves causality

## Time Domain Resolution

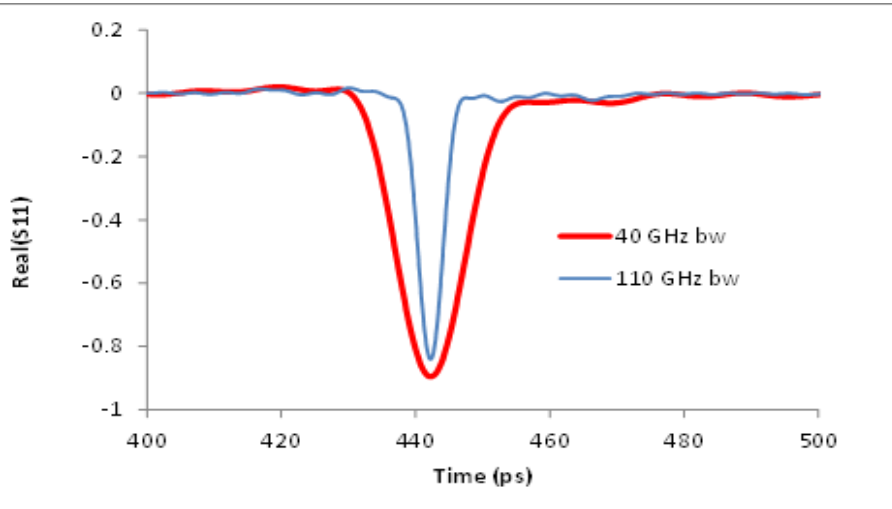

- More bandwidth = better resolution
- Frequency domain only tells you that you have problems
- Hi-res time domain results can tell you where you have problems

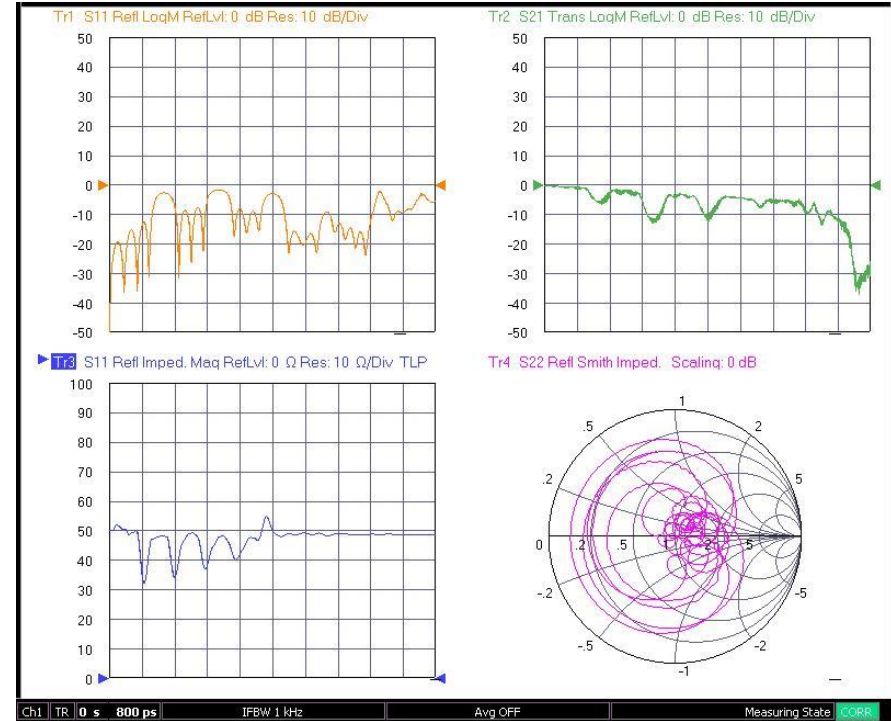



# PSU Signal Integrity Symposium

## Bandwidth and window choices affect causality and resolution

Basic causality is always impacted by available bandwidth. The windows used on the data can also have a major effect. Note the signal levels for  $t < 0$ .

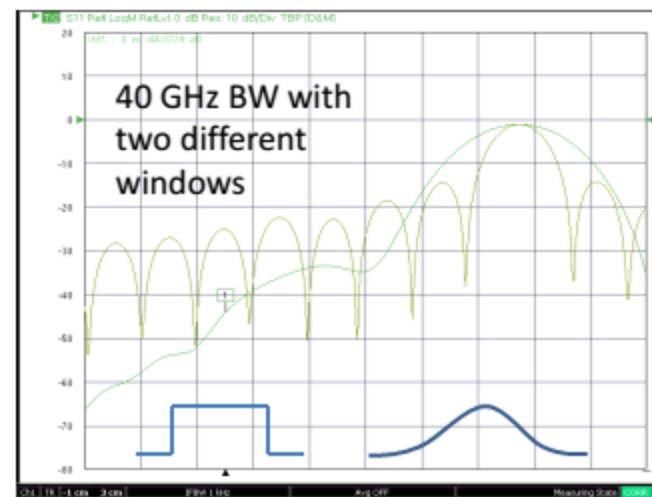
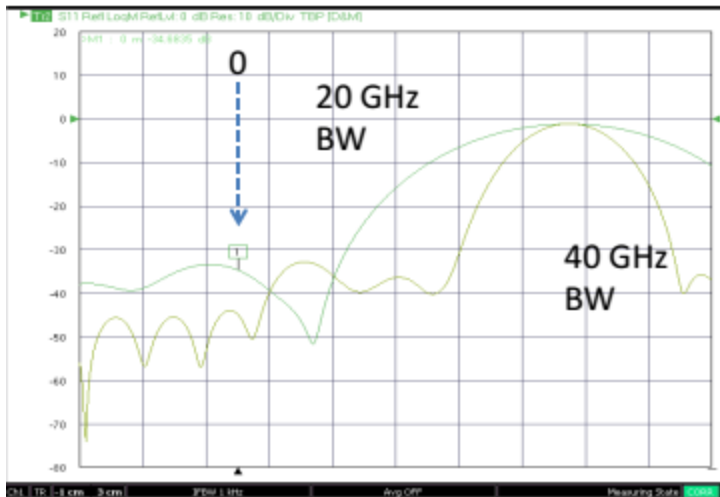

## Importance of Low Frequency Range

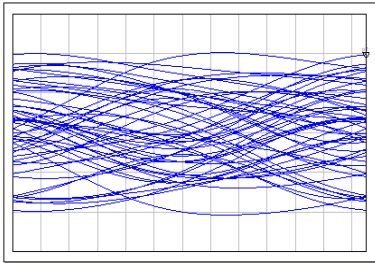

Eye pattern simulated from poor low frequency S-parameter data below 10 MHz

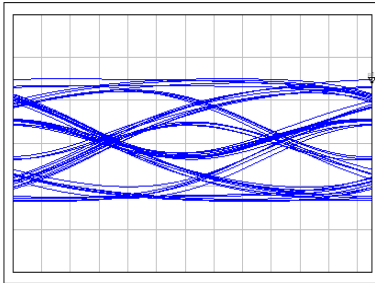

Eye pattern simulated from good low frequency S-parameter data down to 70 kHz

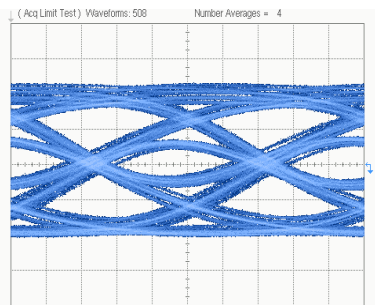

Eye pattern measured with an oscilloscope

## Importance of Low Frequency Range

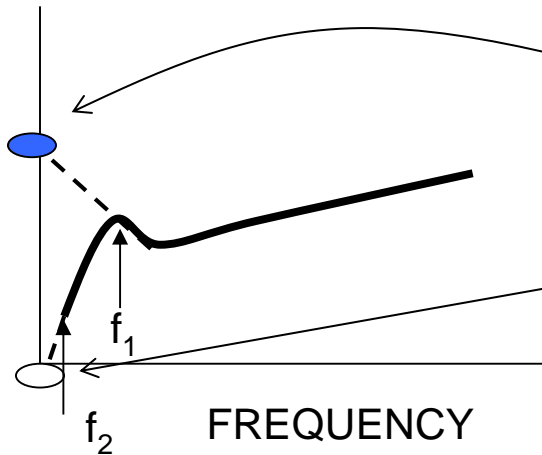

- DC term estimated if start freq  $f_1$
- DC term estimated from lower frequency S-parameter data down to  $f_2$

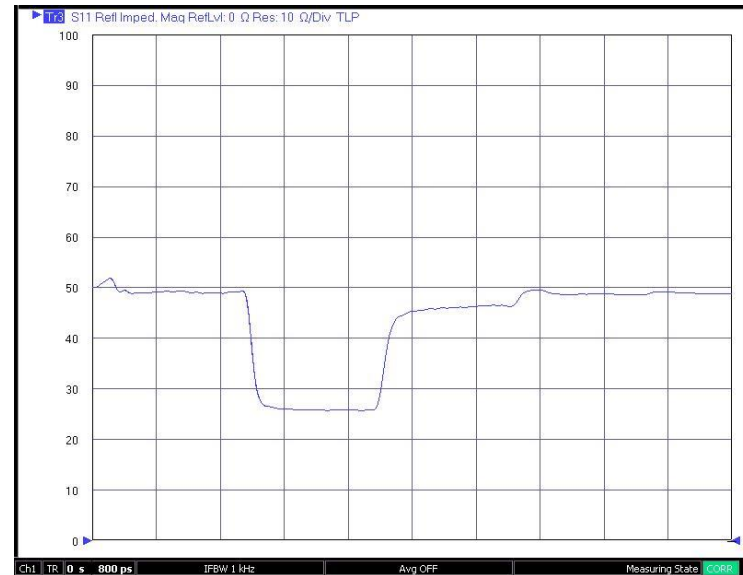
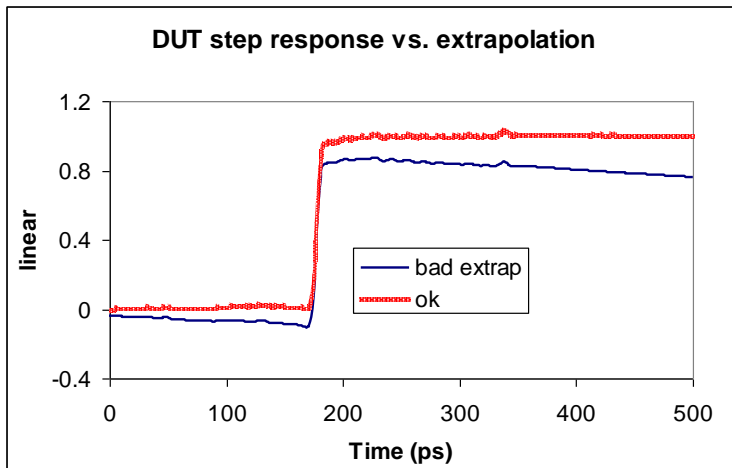

## Importance of Low Frequency Range

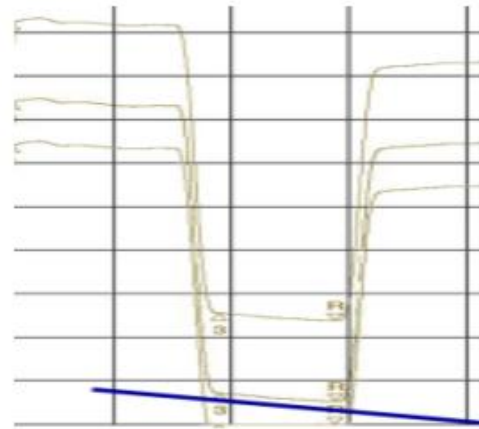
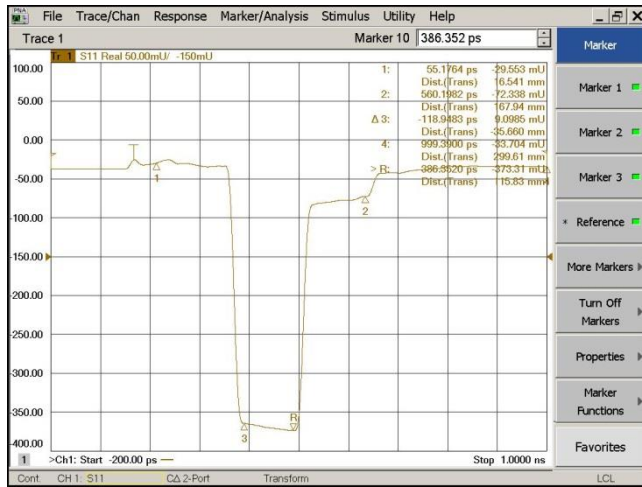

- VectorStar displays a flat 25 ohm section as expected
- Measured Data range from 25.11 to 25.28 ohms
- Low noise on low frequency data give rock-steady results from sweep to sweep

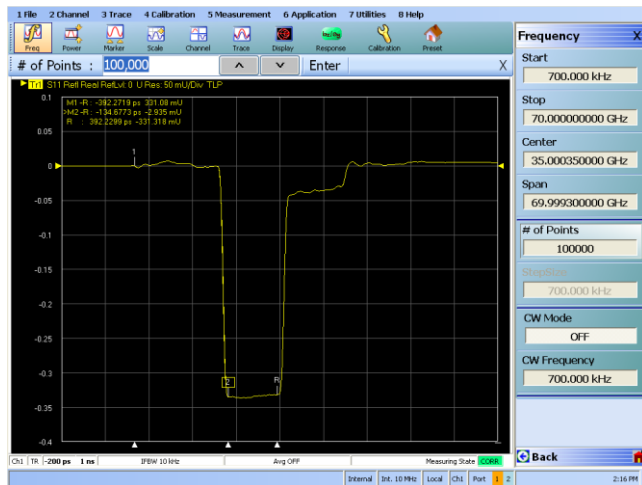

(Composite picture of multiple screen captures showing measurements made on Beatty Standard)

## Need for Low Frequency Data – 2 Reasons

### 1. DC Extrapolation

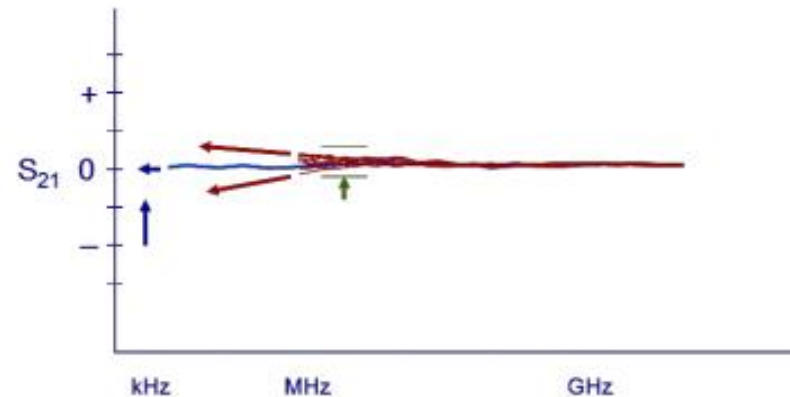
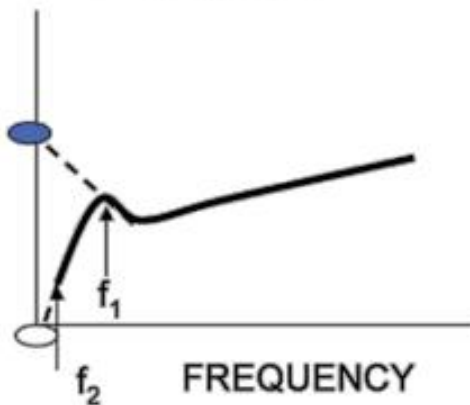

### 2. Sampling in the frequency domain and aliasing\*

- Max unambiguous time domain result:  $T_{\max} = 1/(2f_s)$
- Need to consider multiple reflections

\* A Reverse Nyquist Approach to Understanding the Importance of Low Frequency Information in Scattering Matrices  
Daniel Dvorscak and Michael Tsuk, ANSYSInc, DesignCon 2013

## VNA performance and DC Extrapolation

- Series of measurements made on same 40 inch line
- VNA 1
  - 40 MHz to 40 GHz
  - Couplers for entire band
- VNA 2
  - 4 MHz to 40 GHz
  - Hybrid of bridges and couplers



## VNA performance and DC Extrapolation

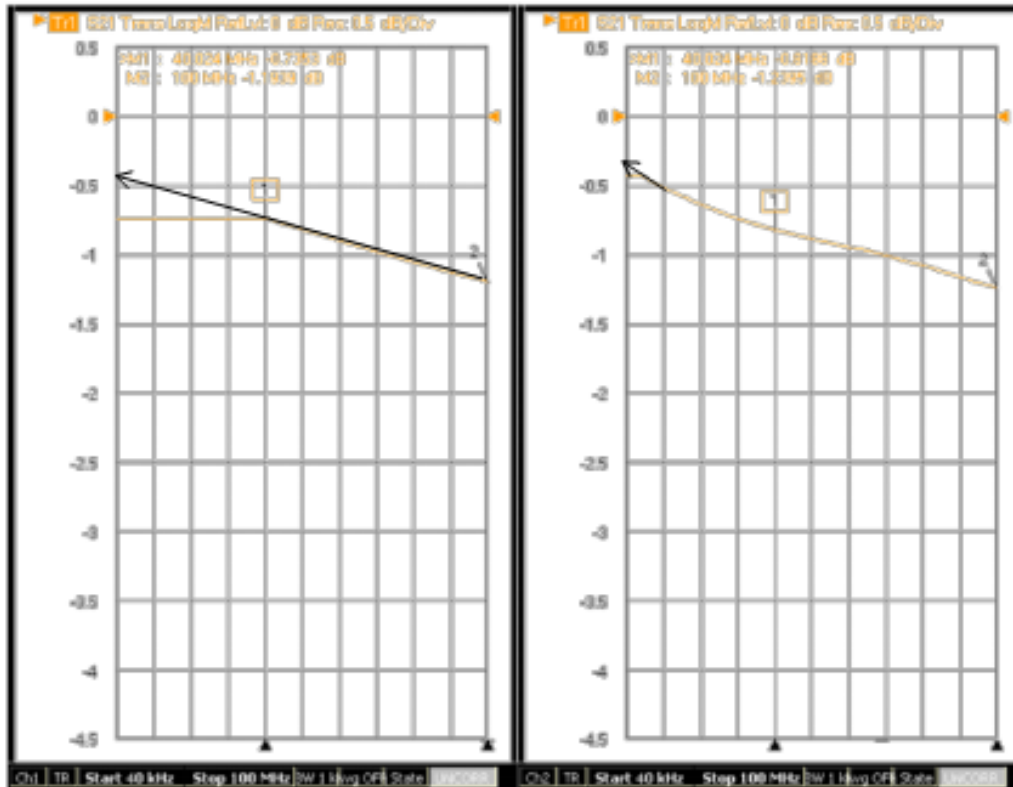

- DC extrapolation depends on quality of S-parameter measurement
- Left trace from VNA limited low frequency performance
  - Coupler based
  - 92 dB DR at 40 MHz
- Right trace from VNA with better low frequency performance
  - Bridges at LF
  - 115 dB DR at 4 MHz

## Impact on step response

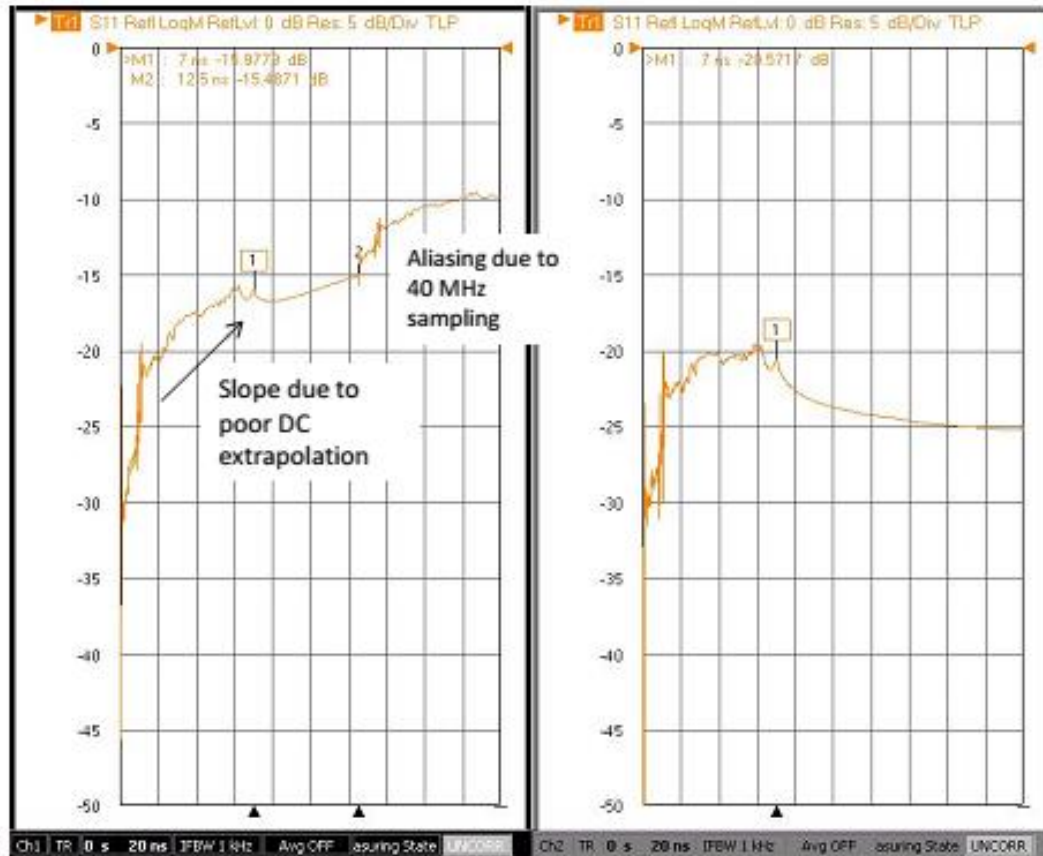

40 MHz to 40 GHz data VNA 1

4 MHz to 40 GHz data VNA 2

- Good low start frequency data improves DC extrapolation
- Low start frequency sets frequency domain sampling for low pass step response and hence alias free range



## Stability at low frequency also critical

Low frequency data issues (drift/instability...) can have an out-sized effect on transformed data because of its criticality to large-distance-scale structure.

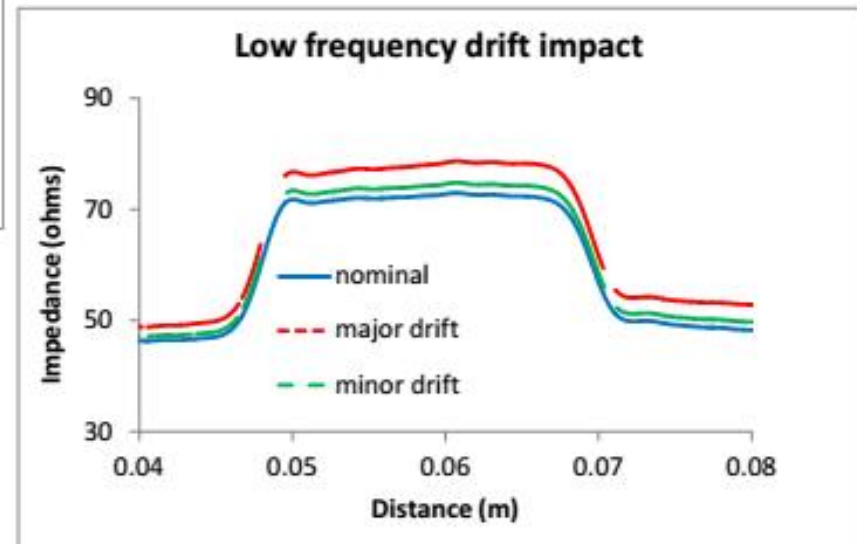
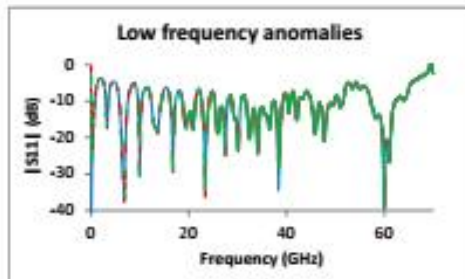
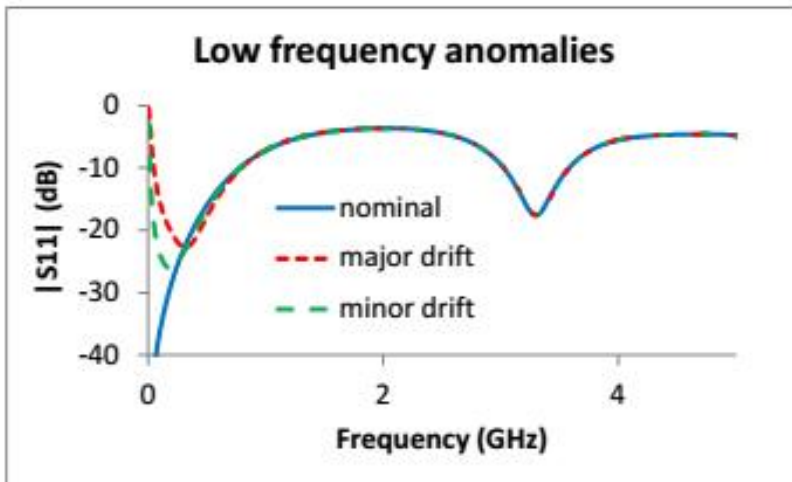

## Eye diagrams – 10 Gbit

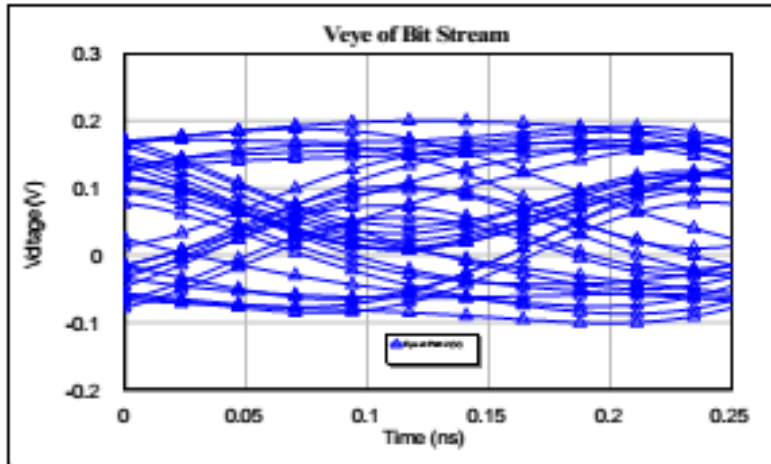

- 10 Gbit
  - data from VNA 1
  - 40 MHz to 40 GHz

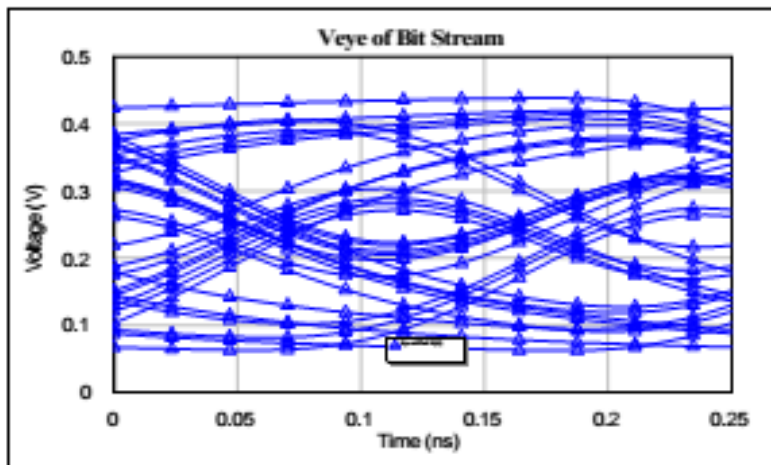

- 10 Gbit
  - Data from VNA 2
  - 4 MHz to 40 GHz

## Low frequency data: uncertainties

Low frequency data is important to the time domain representation since it represents information in the slowly-spatially-varying portions (flat-tops of eye diagrams). Different VNA coupling structures may generate very different uncertainty profiles at low frequency.

*This, in turn, can affect how DC terms are extrapolated...*

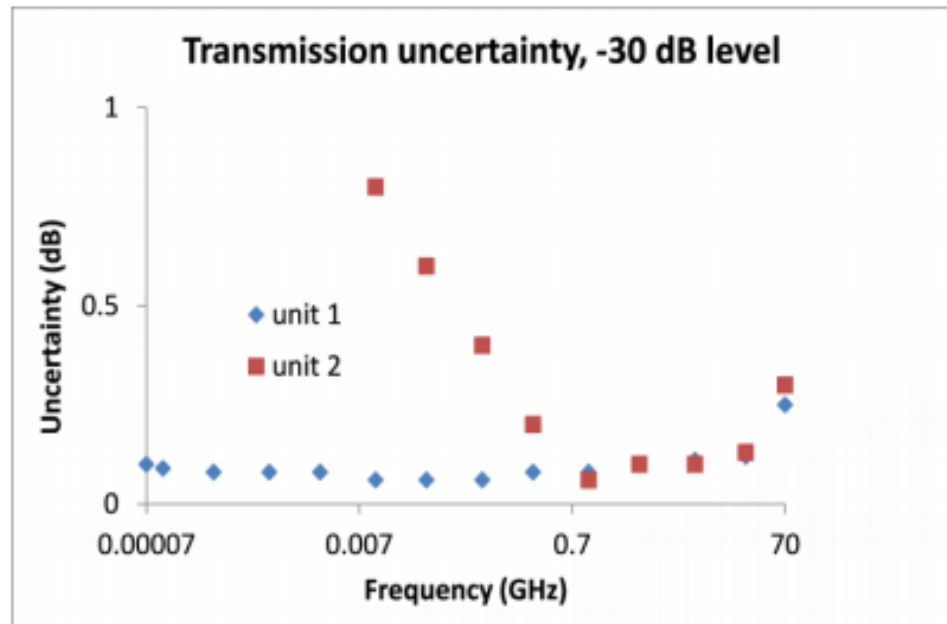

# PSU Signal Integrity Symposium

## Time domain result vs. low frequency uncertainties

A spread of measurement results, using these two uncertainty profiles, were fed into a step-response impedance profile...

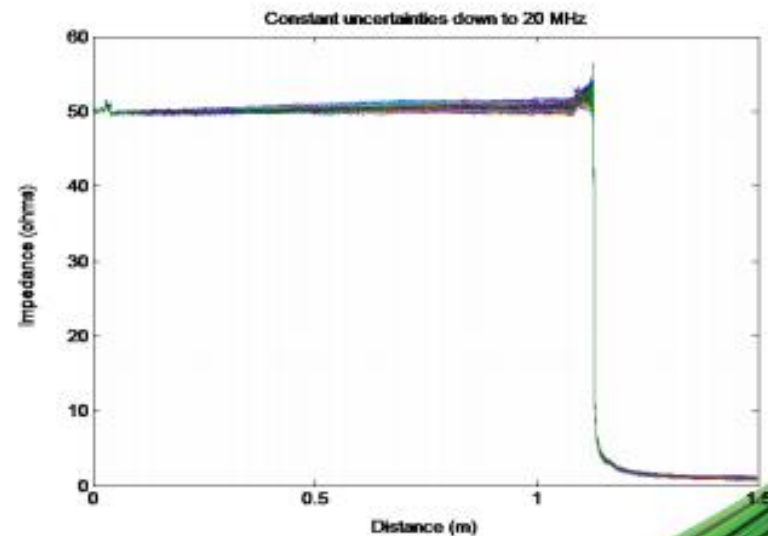
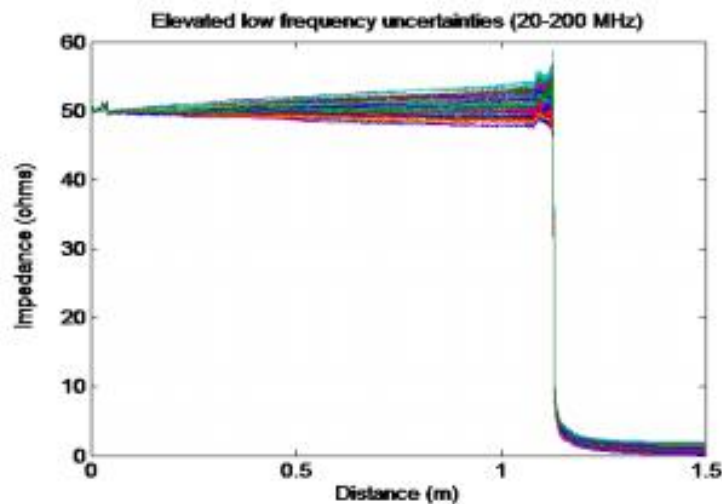

*Elevated low frequency uncertainties perturb the flat portions of step responses more*

## VectorStar Architecture: Two VNAs in One!

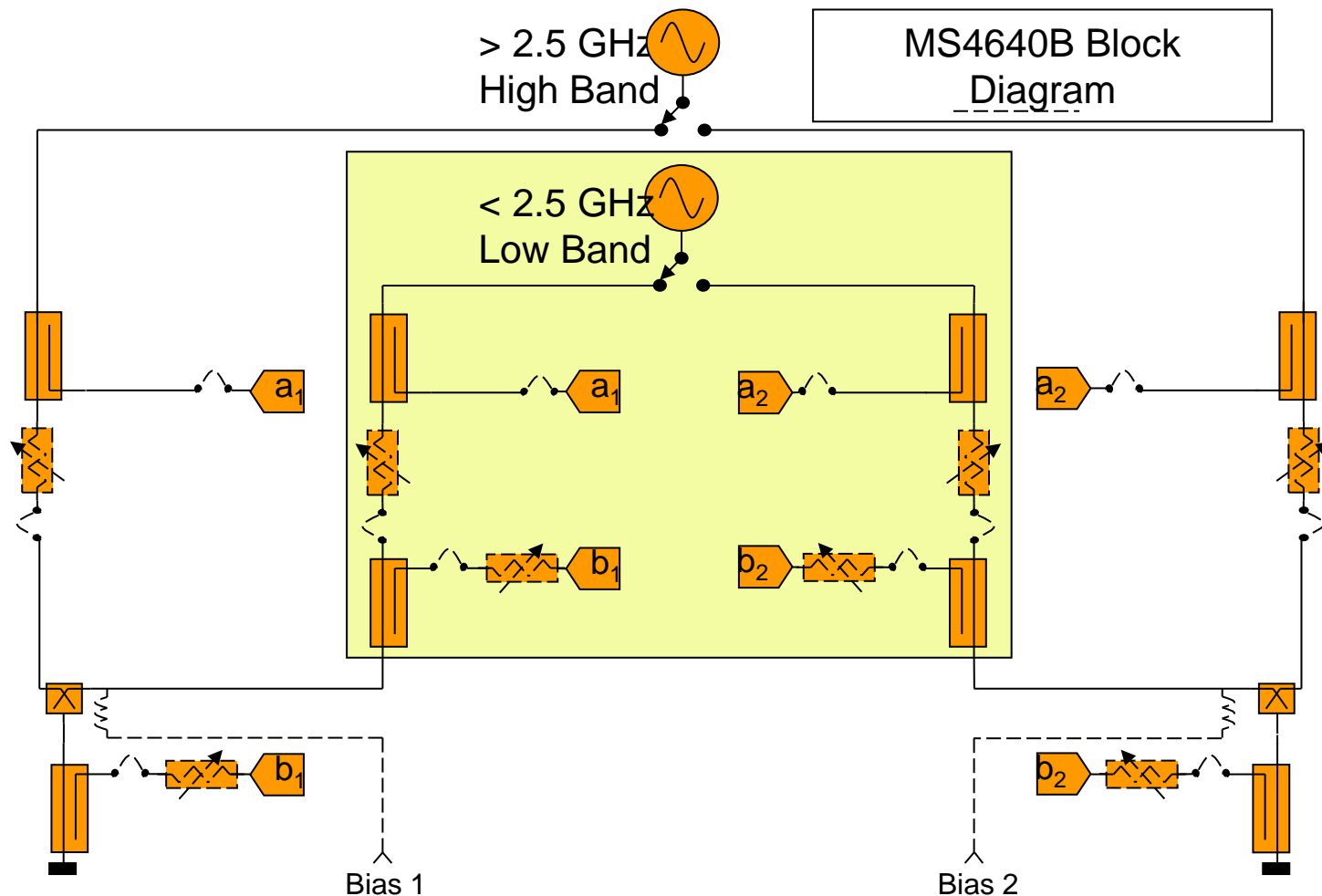

## Unique Hybrid VNA Architecture

- Two VNAs in parallel: Almost the only way to get 6 decades of coverage (from kHz to GHz frequencies)
  - ◆ Each receiver technology (sampler or mixer) used in its best range
  - ◆ Each coupling technology (coupler or bridge) used in its best range
  - ◆ Both share a common IF path and fully synthesized source

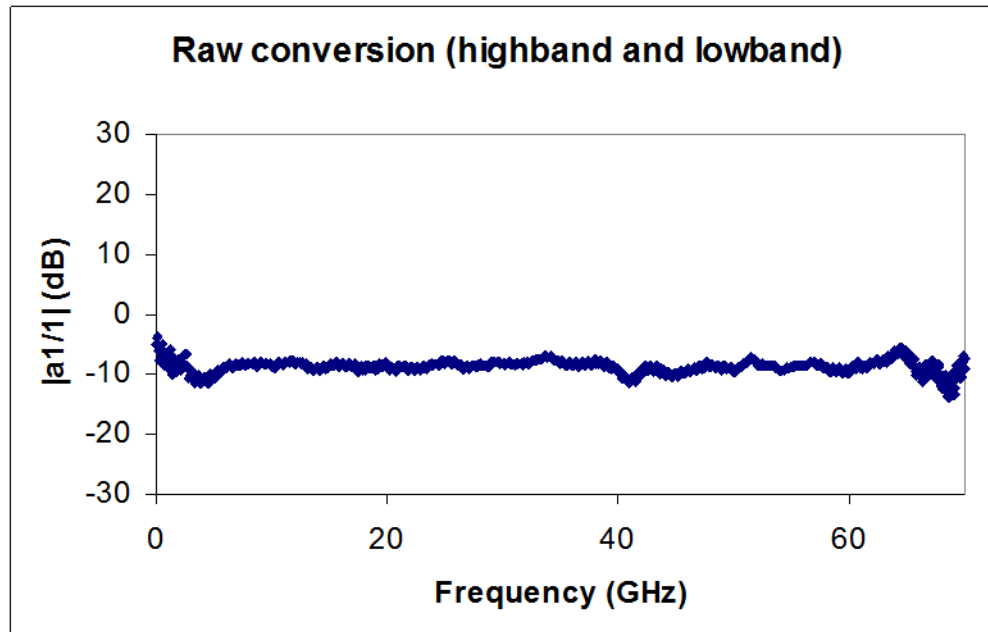

## De-embedding

### Methods available within VectorStar

Method	Standards complexity	Fundamental accuracy	Sensitivity to standards	Media preferences
Type A (adapter removal)	High	High	High (refl.)	Need good reflect and thru stds
Type B (Bauer-Penfield)	Medium	High	High (refl.)	Only need reflect standards, not great for coupled lines
Type C (inner-outer)	High	High	Medium (refl.)	More redundant than A so less sensitive but need good stds still
Type D (2-port lines)	Med	Low for low-loss or mismatched fixtures	Medium (line def'n.)	Only need decent lines; match relegated to lower dependence; can handle coupled lines
Type E (4 port inner-outer)	High	High	Medium (refl.)	Somewhat redundant (like C) but need decent standards. Best for uncoupled multiport fixtures
Type F (4-port uncoupled)	Med	Low for low-loss or mismatched fixtures	Medium (line def'n.)	Only need decent lines; match relegated to lower dependence; can handle coupled lines
Type G (4-port coupled)	Med	Low for low-loss or mismatched fixtures	Medium (line def'n.)	Only need decent lines; match relegated to lower dependence; can handle coupled lines well

Best Accuracy  
Requires good repeatability

Backplanes

## Superposition and True Mode Stimulus

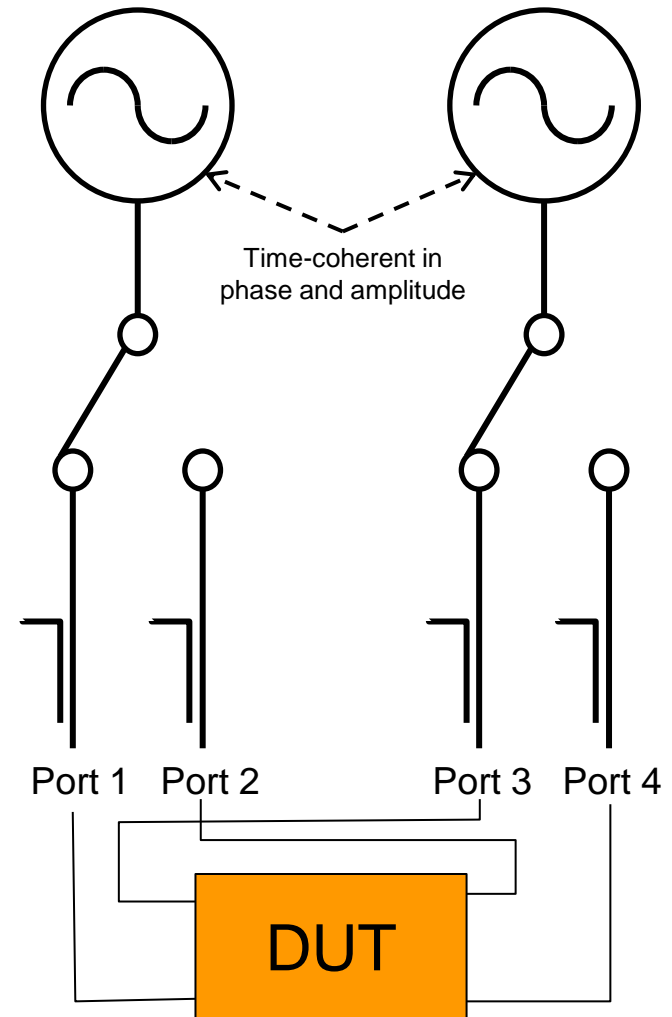
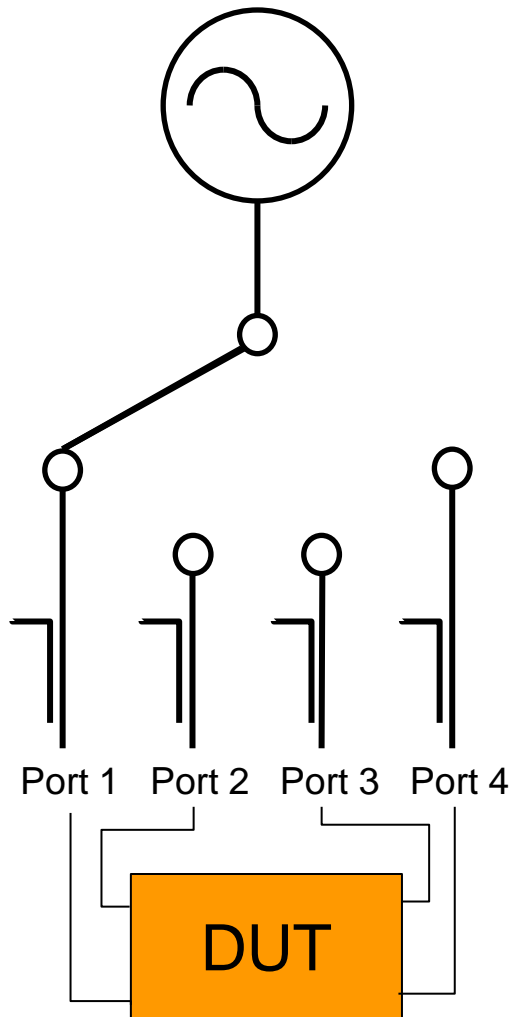



## Applicability of the two methods

Device to be measured:	Superposition	True Mode Stimulus
<b>Passive Balanced / Differential DUT</b>		
Transmission Lines	X	X
PCB	X	X
Lumped Components	X	X
Passive Filters	X	X
Unshielded and Shielded Twisted Pair, Quad Cables	X	X
Connectors / Interfaces	X	X
<b>Linear Active Balanced / Differential DUT</b>		
Linear Amplifiers, Differential Amplifiers	X	X
Linear Active Filters	X	X
Input / Output Match ADC / DAC	X	X
<b>Non Linear Active Balanced / Differential DUT</b>		
Devices in Compression / Saturation		X
Log Amplifiers		X

## Trade Offs

	<b>Superposition</b>	<b>True Mode Stimulus*</b>
Type of VNA	Single source VNA	Dual source required
Method of obtaining Differential and Mixed Mode Parameters	Calculated	Measured directly
Type of DUTs	Passive and active linear	Necessary only for non-linear
Available Frequency Range	70 kHz to 110 GHz	70 kHz - 110 GHz
Calibration Complexity	Typical 4-port	Typical 4-port plus calibration of dual sources
Average Calibration Time	T (Time depends on number of points, IF BW, skill of operator)	Approx. 2T
Calibration stability considerations	Normal measurement calibration intervals	Calibrate more frequently due to stability issues if VNA does not feature advanced correction algorithms
Overall Solution Cost	\$	\$\$

- \* Only recommended when device is non-linear

## Correlation - Measurement and Simulation

- Use Channel Modeling Platform
- Use time domain equipment to measure Eye and compare with simulated Eye

## Use of Channel Modeling Platform

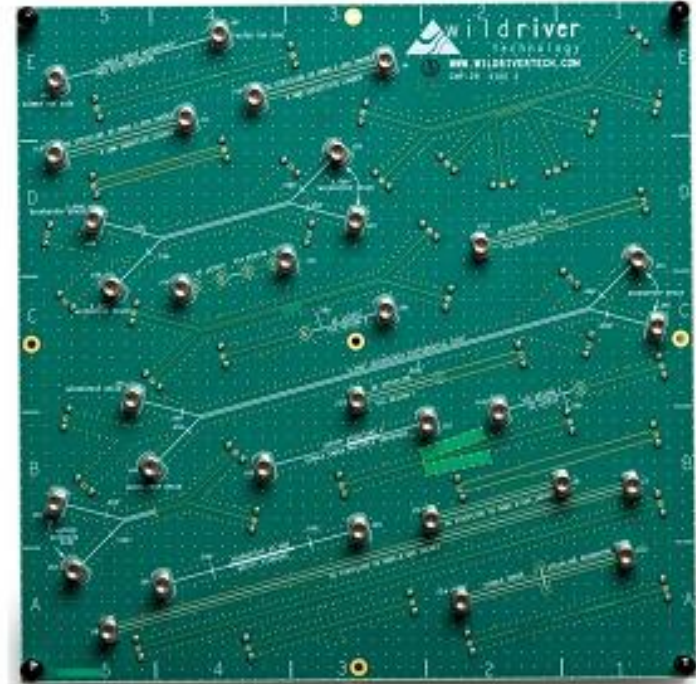
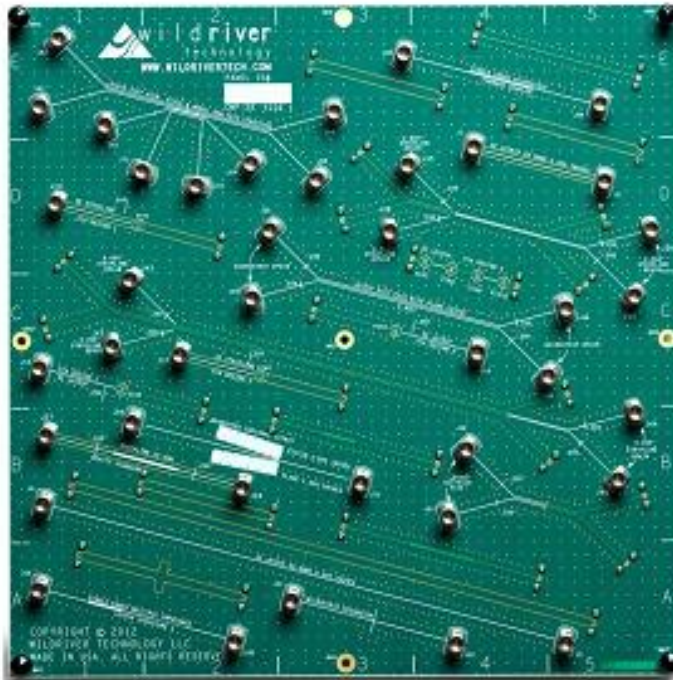

- A set of known structures
- Feed data into models
- Make measurements
- Make comparison

## Lower Risk, Improved Design Flow, Greater Confidence

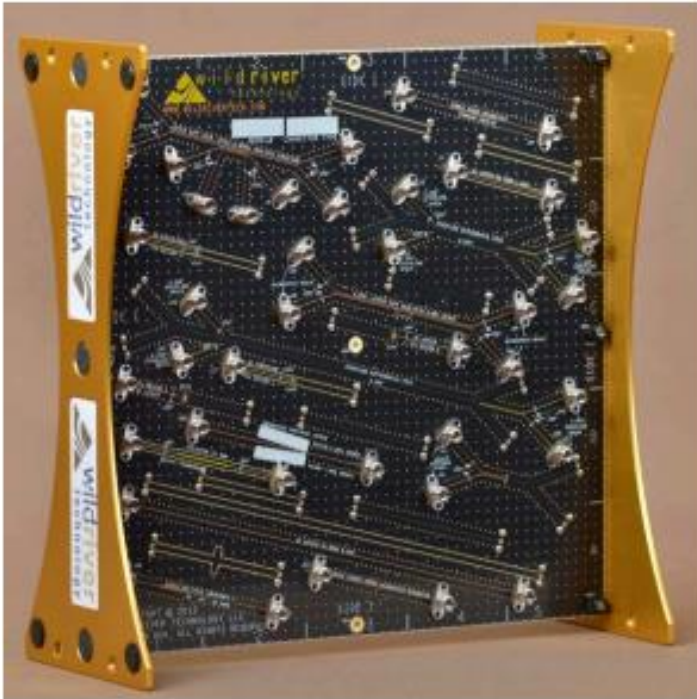

WRT Patented stands provide a stable measurement standard

**CMP-32, 50 GHz, 32 Gbpsec, 2.4mm connectors**

**CMP-28, 40 GHz, 28 Gbpsec, 2.92mm (K) connectors**

## CMP-28 Features- Capabilities



**VIA design** – single-ended and differential VIA, tuned 50ohms, Design pristine DIFF VIA for low jitter at 28Gbps

**Material Extraction and Loss Modeling** – confirm loss models for microstrip and stripline

**Single-Ended Transmission RLGC and W-Element** – compare T-line model with measured S-parameter, impedance profile

**Resonators** – offset, Beatty, and non-offset resonators, validate measurements, loss models, 3D EM

**Differential Transmission Line Analysis** – analyze modes such as SDD11, SDD21

**3D-EM versus measurement** – Meshing- 3 novel mesh challenge circuits that challenge simulators

**Mode Conversion** – plane cutout and differential pathological help analyze SDC21 mode conversion

**Time Domain Validation** – TDR resolution for 10and 28psec  
TDR rise time, graduated ground void

## Simulation to Measurement in Minutes!

1. Import Stack-up - **provided** in package
2. Import Supplied Allegro File - **provided**
3. Establish Mesh, Port Boundaries
4. Check Simulation-Measurements

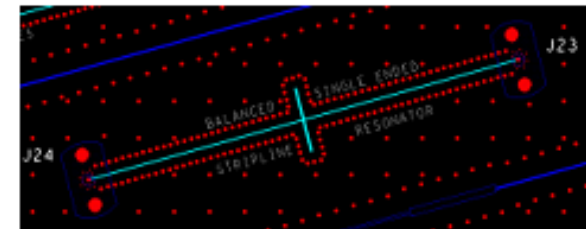
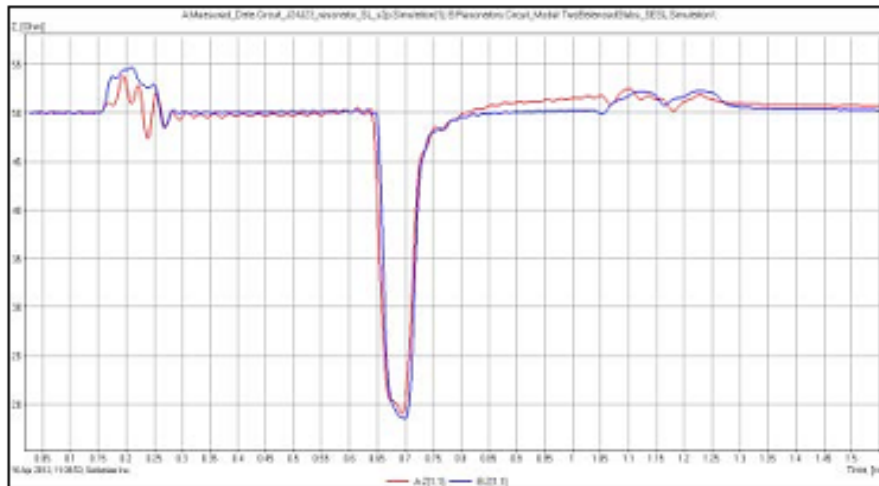

Balanced resonators push 3D-EM and measurement correspondence. CMP-28 has 6 resonators in both microstrip and stripline

This is an example of 3D EM to measurement correspondence using 40GHz VNA S-parameter data that was time domain transformed. Model was developed in minutes using Simbeor.

## 3D EM Challenge Structures – 2 Examples

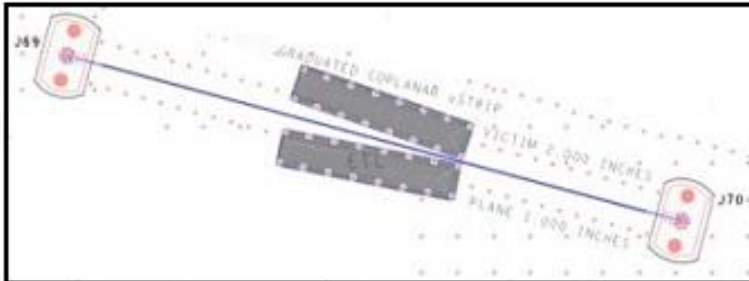

Meshing and Port Boundaries are two key solver potential issues. This circuit challenges mesh with a graduated coplanar structure.

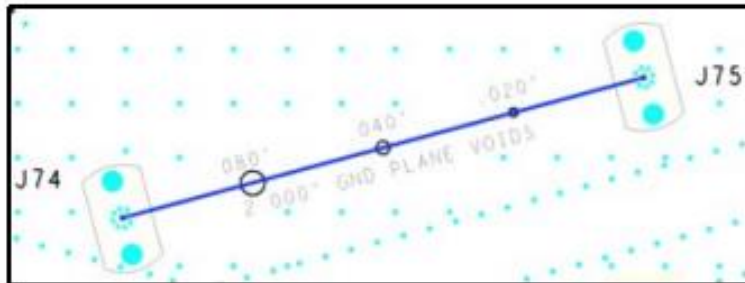

Graduated and periodically placed ground voids challenge 3D EM solver analysis, excellent correspondence vehicle for TDR to time domain simulation to measurement

### Push and Challenge Your 3D EM Solver

*Challenge Meshing, Material Extraction  
Experiment with new structures*

- Ansoft HFSS
- CST Microwave
- ADS EESof EDA
- AWR
- Mentor Hyperlynx



## Potential Simulation Issues – Add Measure + CMP Early in Design Process

1. Reference Planes and Boundary Conditions
  - Both measurements and modeling can have issues
2. Material Modeling
  - Must be adequately modeled across region of interest
3. Artifacts of Ideality
  - You get what you asked for, not what you want
4. Incomplete Verification
  - Did you check what happens on the fringes?
5. Over and Under Modeling

From “**Methods of Improving Time/Frequency Domain Measurement Suited for 3D-EM Simulation**”, DesignCon 2013

# PSU Signal Integrity Symposium

## CMP-28 Measurement Standard + VectorStar = Quality S-Parameter Measurements

	Quality	Passivity
? IndL_cable1J12cable.s2p -	100	96.9
? IndL_calbe1_capL_J12J9.s...	100	98.1
? J10J9_caplaunch.s2p -	100	96
? J12J11_indlaunch.s2p -	100	96.6
? J13cable1_VIA1cable.s2p -	100	97.8
? J13J14_VIA11.s2p -	100	97.5
? J19J20_VIA2.s2p -	100	96.4
? J1J2_ustrip_2inch.s2p -	100	97.5
? J24_cable1_resonator.s2p -	100	97.3
? J24J23_stripresonator.s2p -	100	97.1
? J29_cable1_multiimpd.s2p -	100	97.2
? J29J30_multiimpedance_u...	100	95
? J3J4_ustrip_8inches.s2p -	100	98.8
? J68J67_whiskers.s2p -	100	95.8
? J70J69_coplanargraduate....	100	98.1

Simbeor 2013 was used to assess the quality of CMP-28 measurements on VectorStar. Quality metrics vary from 0 to 100%, where these metrics are very high.

Quality metrics depends on VNA design and quality, drift, calibration kit.

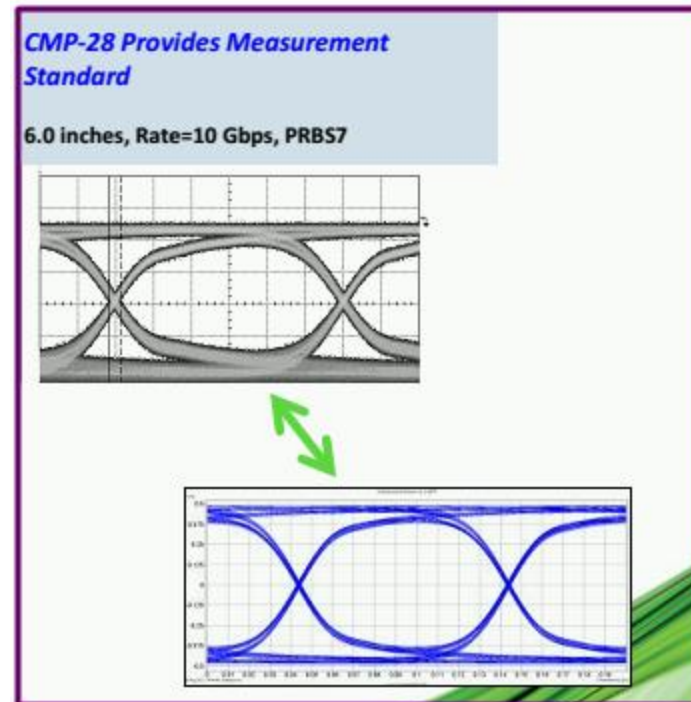

# PSU Signal Integrity Symposium

## DUT: Overlay S-parameter-based results with direct BERT measurements

From the S-parameter simulated data, a time domain model can be generated and the resulting calculated eye diagrams compared against direct BERT measurements for different lines and different data rates.

*blue*—direct BERT measurement; *red*—time domain model based on S-parameter data

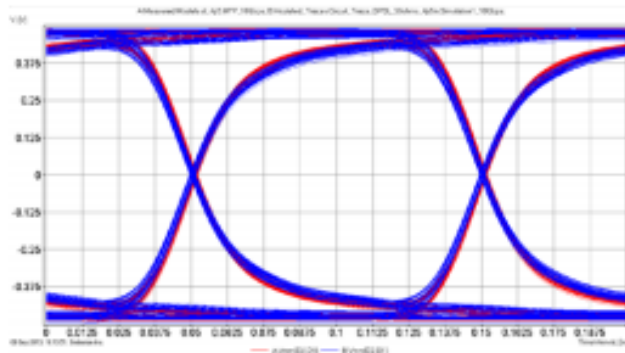

4.5 inch microstrip @ 10 Gbps

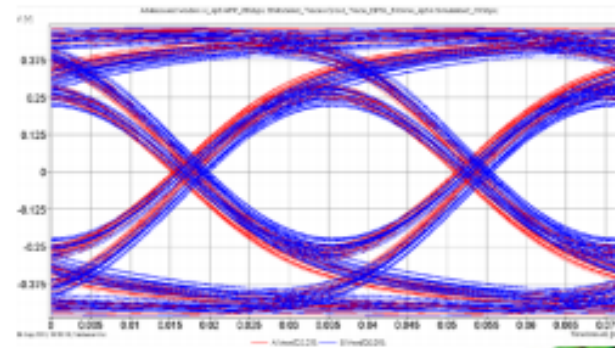

4.5 inch microstrip @ 28 Gbps

# Questions?

Thank You